

HYGIENE & MAINTENANCE

Create it 

HYGIENE & MAINTENANCE



NSK

Safer and more comfortable everyday dental care.

Even the most advanced handpiece is worthless if it cannot be operated safely and reliably. As a trusted global manufacturer of handpieces NSK strives to ensure the highest standard of performance through advanced technologies.

NSK offers solutions to cover the entire decontamination cycle - cleaning, lubrication and sterilisation to help maintain safe and reliable operation.

INDEX

iCare+	P 03 - 06
iCare	P 07 - 10
iClave 18 & 24	P 11 - 14
iClave plus	P 15 - 18
PANA SPRAY Plus / Multi Stand	P 19 - 20
Spare parts and Accessories	P 21

iCare+

Automatic system for cleaning, disinfecting and lubricating rotary instruments

Manual cleaning of instruments does not remove all deposits and residues. Dynamic instruments that are poorly maintained or not adequately cleaned may become damaged and pass on infections to both patients and practitioners. Any instrument used in dentistry must be perfectly cleaned, disinfected and maintained. NSK is aware of the requirements in the daily practice of dentistry and, after many years of research, it has come up with a simple and effective solution thanks to iCare+.

Advantages

- Simplicity
- Automatic
- Speed
- Constant monitoring of working parameters for consistent performance
- Universal connection of dynamic instruments
- Validation
- Traceability
- Detects instrument type spray / water external or internal
- Consistent repetition of cycles



Intelligence at the service of your instruments

iCare+ is smart and detects the type of instrument attached to the ports (internal/external spray or without spray), when canals are blocked or the wrong cycle has been selected for a specific instrument to ensure cycle efficiency. During the different cycles, iCare+ starts the rotation of instruments and injection of treatment products into all the internal mechanisms and tubing of the instruments to provide deep cleaning and disinfection; a pressure spray simultaneously cleans and disinfects the external surfaces. Each cycle lasts for a specific duration in compliance with EN ISO 15883-1/15883-5 to guarantee maximum effectiveness of the n.clean and n.cid solution for the perfect treatment of every instrument.

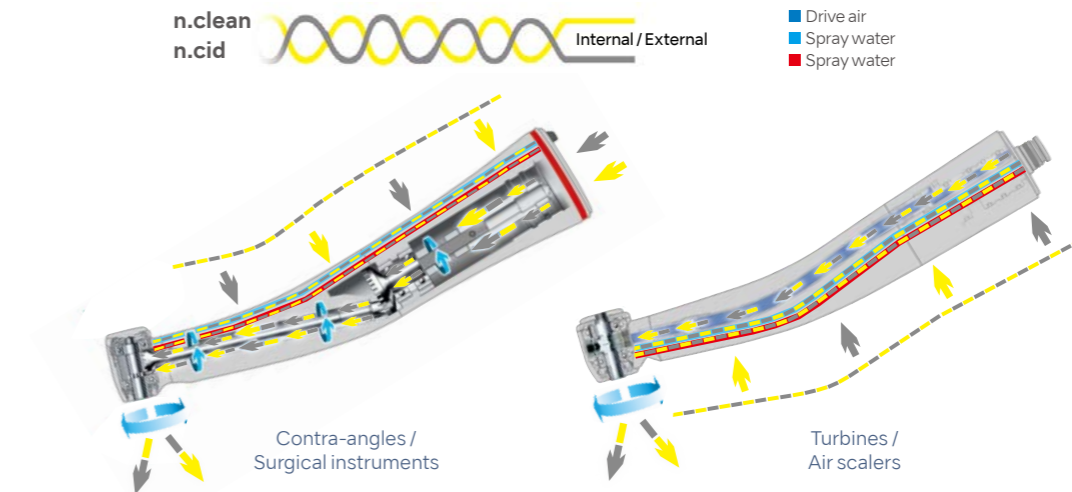

Security

Tests performed by the Dr. Brill Institute conducted on extremely dirty instruments (containing sheep's blood with heparine, protamine, bacteria and yeast) prove that iCare+ treatment cycles together with n.clean cleaning and n.cid disinfection guarantee proven effectiveness of the results. The validated tests realized in Germany by this accredited laboratory were done according to RKI recommendations (Robert Koch Institute) and EN ISO 15883-1.

99.999% of bacteria is eliminated

iCare+ makes it possible to reduce proteins to less than 100 mg per instrument after treatment. Thus, the reduction in the level of microbial contamination (> 5-log step) of the instruments treated is equivalent to eliminating over 99.999% of the bacteria.

Guaranteed consistent repetition of cycles

iCare+'s internal control system has sensors, which ensure consistency of every cycle in accordance with the parameters which were determined during the laboratory tests. iCare+ is a medical device which has a protocol, a method of analysis, and certifiable results.

Cleaning and Disinfection

Two Products Inextricably Linked to iCare+

iCare+ working hand in hand with n.clean and n.cid products. n.clean and n.cid have been specifically developed for rotary instruments in compliance with laboratory protocols as well European and International standards.

Validated Association of Certified Products

Extensive laboratory tests have been conducted on NSK turbines, handpieces and contra-angles, as well as on instruments from other brands: the results are identical for all tested instruments and always in compliance with EN ISO 15883-1. It is therefore crucial that iCare+ be used together with n.clean for cleaning and n.cid for disinfection of rotary instruments to guarantee optimal results validated by laboratories.



Targeted Action

n.clean, a cleaning and rinsing solution, acts as a detergent and has bacteriostatic and fungistatic effects. It prevents proteins from attaching to internal and external surfaces of instruments. Disinfection prior to sterilisation is carried out by n.cid, a bactericidal, fungicidal and virucidal* disinfectant solution effective against wrapped viruses, as well as unwrapped Adeno viruses.

*Bactericidal: TBC, MRSA. - Fungicidal: Candida albicans - Virucidal: HBV, HCV, HIV, Herpes simplex, Influenza, H1N1 + H5N1.

Complete Traceability

Internal Traceability Software

In addition to the permanent internal validation process, software is available to log all cycle data on an external device. iCare+ generates a serial number for every cycle. Once the data has been transferred to a computer you can add serial numbers of individual instruments to specific cycle records in order to establish total traceability.



Data Storage

To allow traceability and external storage of the iCare+ cycle data an easily accessible USB port is built into iCare+ unit.*

User-friendly Interface

The user friendly software interface allows easy and efficient management of all cycle data with the option of adding specific records for individual instruments at the push of a button.

Easy to use

The clearly and intuitively arranged control panel together with the LED indicators and the internally lit treatment chamber, which clearly indicates operating mode, makes it really easy to operate iCare+.

- Yellow for cleaning
- White for disinfection
- Blue for lubrication
- When the green LED lights up, the process is complete.



iCare+ Complete Sets

Dual standard ports + Dual rotation ports		Single standard port + Triple rotation ports	
MODEL	ORDER CODE	MODEL	ORDER CODE
iCare+ C2	S102001	iCare+ C3	S103001

Contents

- iCare+ unit
- Power cord with L-shaped plug
- Air tube
- Notice on DVD

Specifications

- Power Supply : AC 100-230 V 50/60 Hz
- Capacity : up to 4 instruments
- Air Pressure : 0.5-0.6 MPa (5.0-6.0 kgf/cm²)
- Weight : 14 kg
- Dimension : W 400 x D 405 x H 355 mm
- Capacity of the oil tank : 500 mL
- Capacity of the bottles for the cleaning and isinfection product : 500 mL
- *Connects only to Midwest 4-hole type *An airline is necessary (5.0-6.0 kgf/cm²)



iCare+ Adaptors

MODEL	ORDER CODE	
iCare+ Adaptor PTL	Z1127010	• For NSK high speed handpieces for PTL coupling
iCare+ Adaptor KV	Z1127011	• For KaVo® high speed handpieces for Multiflex® coupling
iCare+ Adaptor SR	Z1127013	• For Sirona® high speed handpieces for Quick coupling
iCare+ Adaptor WH	Z1127012	• For W&H® high speed handpieces for Roto Quick® coupling
iCare+ Adaptor BA	Z1127014	• For Bien Air® high speed handpieces for UNIFIX® coupling

Check with your dealer for the correct adaptors to use for your high speed handpieces.

Pressure regulator

MODEL	ORDER CODE
Pressure regulator for iCare+	S103500

Refill Maintenance Oil

MODEL	ORDER CODE
n.clean, 500 ml PEHD bottle (6 pcs)	ACL600
n.cid, 500 ml PEHD bottle (6 pcs)	ACD600



MODEL	ORDER CODE
Maintenance oil for iCare+ (1 litre)	Z016117



iCare

Automatically Lubricates

iCare sets a new standard for handpiece maintenance systems. In one stylish and compact body, it offers you both ease of use and multiple functions to achieve complete lubrication. The proper solution volume is preset based on handpiece type, and maintenance can be initiated at the touch of a button. The chuck cleaning system keeps chucks pristine, and the purging select mode lets you alter purge time depending on the situation for truly comprehensive maintenance. Thanks to its stylish and compact body, iCare is also space efficient and totally in harmony with your working environment.

Advantages

- Preset solution volume based on handpiece type (high-speed handpieces, low-speed handpieces)
- Chuck cleaning function ensures that the chuck is thoroughly cleaned and lubricated
- Purging select mode ensures complete removal of excess oil
- Integrated large oil tank (1.2 Liters) reduces the burden of refilling



Ergonomic and easily readable large panel

Simple one-touch operation to start lubrication.

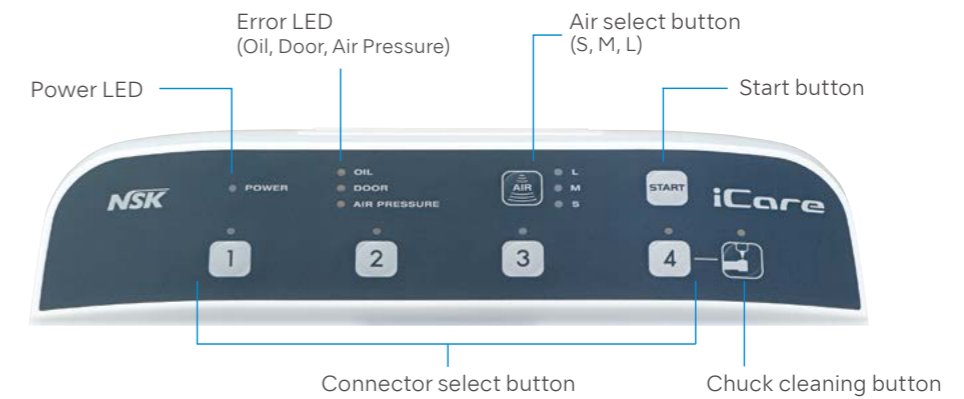

Preset proper solution volume based on handpiece type

The proper solution volume is preset based on high speed and low speed handpieces, ensuring precise and thorough lubrication at the touch of a button.

High speed handpieces

iCare meticulously lubricates the components of high speed handpieces.

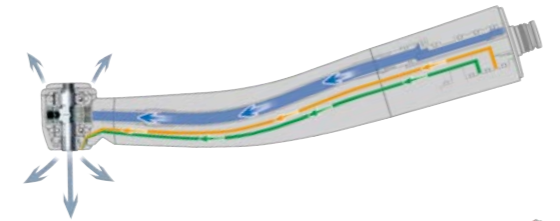

Low speed handpieces

Low speed handpieces incorporate gearing systems that require extra solution penetration. The NSK rotation system guarantees optimum oil delivery to the internal components of all low-speed handpieces.

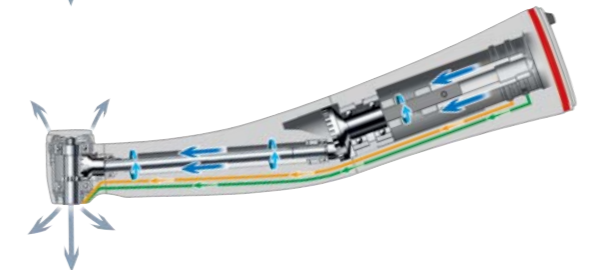

Accommodates both NSK handpieces and those of other brands

NSK and all other brands of low speed handpieces connect directly to the fitting supplied. NSK high speed handpieces require the PTL adaptor. Adaptors are available for connection of most other high speed brands.

Purging select mode

After lubrication, you can select from appropriate modes offering different purge lengths - short, medium and long.



Chuck cleaning function

The chuck cleaning function completely removes dirt and cutting powder from the chuck.



HP head filter prevents mist leaks (Optional)

Handpiece head filters are made to absorb any spray mist generated.



Easy to clean

iCare's front door can completely removed to allow fast, easy cleaning.



Solution tank

iCare's big solution tank has a capacity of 1.2 litres allowing you to pour in a full one litre bottle of maintenance solution at once, reducing the necessity for frequent refilling. The enclosed nozzle enables clean and easy refilling.



Safe operation with a range of alarm functions

The alarm LED ensures safe and secure maintenance by alerting you to various situations, including inadequate solution and an unclosed door.

Stylish and compact

In the pursuit of 'ultimate ease-of-use', the iCare performs automatic maintenance of up to four handpieces at once. iCare is also designed to be simple to set up and space efficient, you can install it virtually anywhere.



iCare Complete Sets



**Dual standard connectors +
Dual rotation connectors**

MODEL	ORDER CODE
iCare C2 Type	Y1002787



**Single standard connector +
Triple rotation connectors**

MODEL	ORDER CODE
iCare C3 Type	Y1002788



Contents

• iCare unit • Power cord • Chuck cleaning nozzle • Maintenance oil for iCare (1 Liter) • Mist filter set
• Oil absorber sheet • Air tube

Specifications

• Power supply : AC 100-240 V 50/60 Hz
• Air pressure : 0.5-0.6 MPa (5.0-6.0 kgf/cm²)
• Weight : 6.5 kg (C2 type / C3 type)
• Dimension : W 280 x D 240 x H 350 mm
• Solution tank capacity : 1.2 L

• Connects only to Midwest 4-hole type
• An air line is necessary (5.0-6.0 kgf/cm²)
• Do not use iCare to lubricate air scalers (except NSK S970 series) and Phatelus air motors. The iCare lubricating system is not designed to lubricate those particular products. Maintain air scalers and Phatelus air motors as described in the operation manual for each product.
• If blood infiltrates inside a handpiece, iCare may not totally clean the internal handpiece components, and internal blood coagulation may cause product failure. In this case, NSK recommends to immediately lubricate those handpieces manually with PANA SPRAY Plus.

iCare Adaptors

MODEL	ORDER CODE	
PTL Adaptor	Z257010	• For NSK high speed handpieces for PTL coupling
B2/M4 Adaptor	T904	• For Borden 2 hole high speed handpieces
KV Adaptor	Z257020	• For KaVo® high speed handpieces for Multiflex® coupling
SR Adaptor	Z257023	• For Sirona® high speed handpieces for Quick coupling
WH Adaptor	Z257021	• For W&H® high speed handpieces for Roto Quick® coupling
BA Adaptor	Z280022	• For Bien Air® high speed handpieces for UNIFIX® coupling
F-Type Adaptor	Z280042	• For ENDO-MATE TC2, DT2 heads

Check with your dealer for the correct adaptors to use for your high speed handpieces.

Refill Maintenance Oil

MODEL	ORDER CODE
Maintenance oil for iCare (1 bottle, 1 litre)	Z016130
MODEL	ORDER CODE
Maintenance oil for iCare (Pack of 6 bottles)	Y1002783



MODEL	ORDER CODE
Mist Filter Set • Pack of 12	Y900159
MODEL	ORDER CODE
Oil Absorber Sheet • Pack of 10	U433135



iClave 18 & 24 EN 13060 : Class B & S

The comfort you wanted.

Sterilising dental instruments is crucial for patients' and operators' safety. The new iClave autoclave perfectly combines performance, user experience, and technology, ensuring an effective, comfortable, and worry-free experience.

Its stainless steel chamber, with 5 trays of 2 different dimensions, maximises the actual capacity. In addition, the new high-efficiency steam generator allows for superior performance, resulting in perfectly sterilised equipment in less time.

But there's more. The user-friendly iClave colour touchscreen, elegant, ergonomic design, and cutting-edge technology make it a safe, efficient device that is also a pleasure to use.

NSK's unmistakable quality and reliability ensures impeccable sterilisation, making an iClave the effective and comfortable answer to your needs.



Performance

Optimised load capacity

Not all autoclaves are the same. The 24-liter version of iClave has an actual capacity of up to 7 kg – taking it to the top of its category. Its 5-tray system, allows you to exploit all the room inside the chamber.

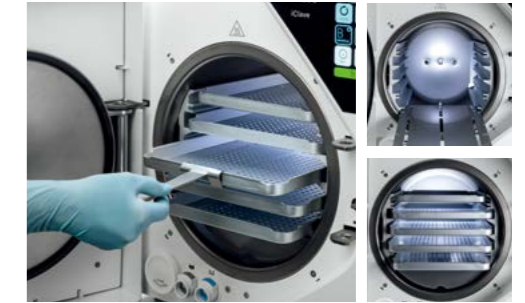
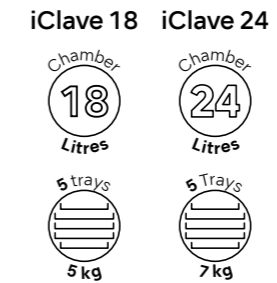

Fast cycle, excellent performance

The new high-efficiency steam generator with stainless steel coil injects the steam into the chamber, into the middle of the tray holders, which act as heat accumulators, enabling a more even distribution of heat and lessening its impact on the instruments. The heat accumulated by the tray holders is released to the load during the drying phases, guaranteeing perfect, rapid drying. Together with the design of the chamber, the trays and the water circuit, this system enables rapid Class B and Class S cycles.

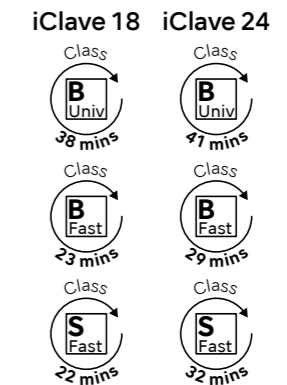

Internal ventilation

The internal ventilation system is effective and durable. It is also a very quiet ventilation system, which translates into long-lasting performance and more comfort for the operator.



User Experience

A next-generation experience

iClave's 4.3" capacitive colour touchscreen is extremely straightforward, and can even be used while wearing gloves. This way, managing every function – from programming cycles to running tests – is a safe and satisfying experience, ensuring perfect sterilisation.



A faster, safer, and more practical way to manage water

iClave's chemical-resistant clean water tank is easy to fill and clean. It also has a filter you can easily remove and replace. In addition, the two quick connectors for used water and clean water drainage respectively ensure these operations can be handled safely and extremely practically, because the water can only drain away if the tube is inserted into the connector, making the operation extremely user-friendly.



Technology

Easy, worry-free traceability thanks to the built-in or external printer

Tracking the sterilisation data of every load and every instrument allows dentists and their teams to safely store them ready for use, knowing exactly when they were sterilised. The iClave's built-in or external printer meet this requirement by printing reports and labels, thus boosting safety, for the peace of mind of both dentist and patient.



Built-in printer External printer

Store data wherever you want with a USB flash drive

Another way to store sterilisation and periodic test data is by using a USB flash drive, which allows you to transfer all the information from the autoclave to a computer and save it wherever you want.



Technical Data

Sterilisation cycles

iClave is a steam steriliser for materials and medical devices that are likely to come into contact with blood and body fluids. Based on the requirements of the EN 13060 standard for small sterilisers, it is suitable for the following sterilisation cycles and loads:

Class B Sterilisation of wrapped and unwrapped solid, porous, and hollow instruments, as represented by the test loads in the standard.

Class S Sterilisation of unwrapped solid products.

CYCLE	TEMPERATURE	STERILISATION	DRYING TIME	TYPICAL LOAD	TYPICAL LOAD CYCLE TIME	MAX LOAD	MAX LOAD CYCLE TIME
B Universal	134°C	4' 00"	10'	2 kg	38' (iClave 18) 41' (iClave 24)	5 kg (iClave 18) 7 kg (iClave 24)	51' (iClave 18) 59' (iClave 24)
B Prion	134°C	18' 30"	14'	2 kg	59' (iClave 18) 62' (iClave 24)	5 kg (iClave 18) 7 kg (iClave 24)	72' (iClave 18) 78' (iClave 24)
B Fast	134°C	3' 30"	5'	-	-	0.5 kg (iClave 18) 0.7 kg (iClave 24) *	23' (iClave 18) 29' (iClave 24)
B 121	121°C	20' 30"	16'	2 kg	61' (iClave 18) 67' (iClave 24)	5 kg (iClave 18) 7 kg (iClave 24)	76' (iClave 18) 82' (iClave 24)
S Fast	134°C	3' 30"	7'	-	-	1 kg (iClave 18) 2 kg (iClave 24)	22' (iClave 18) 32' (iClave 24)

* Use only one tray in the second slot, starting from the bottom. Only for solids, hollow wrapped and unwrapped.

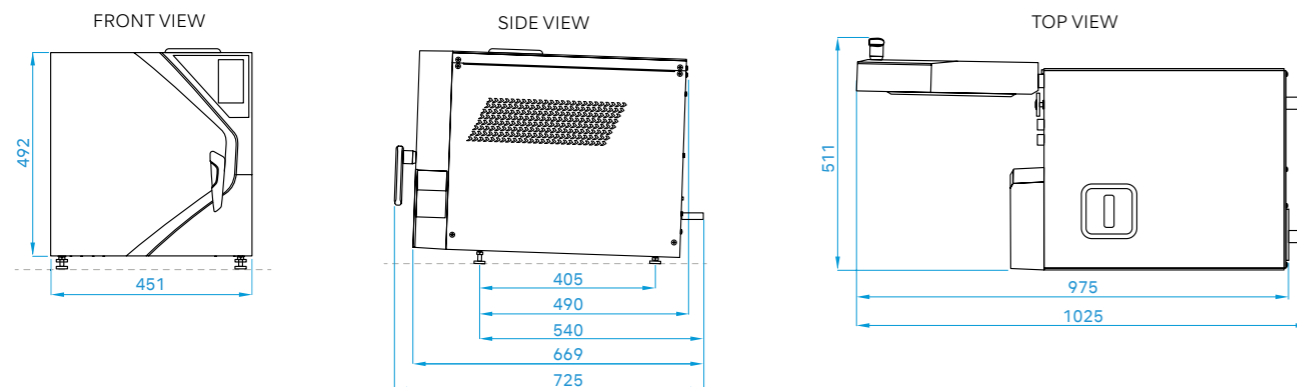

iClave 18 Complete Set

MODEL	ORDER CODE
iClave 18 (excluding printer)	91812B0100
iClave 18 (including printer)	91812B0100P

Technical characteristics

- External dimensions: 451 x 492 x 669 mm (L x H x D)
- Chamber dimensions: Ø 265 - 368 mm (D)
- Chamber capacity: 18 litre
- Loadless weight: 52 kg
- Power consumption: 2,300 W
- Supply Voltage: AC 230 V - 50/60 Hz
- Cycle water consumption*: 700 - 800 cc
- Tank capacity (clean and used water): 5 litres each
- Sound level: 60 dB (A)

iClave 24 Complete Set

MODEL	ORDER CODE
iClave 24 (excluding printer)	92412B0100
iClave 24 (including printer)	92412B0100P

Technical characteristics

- External dimensions: 451 x 492 x 669 mm (L x H x D)
- Chamber dimensions: Ø 265 - 475 mm (D)
- Chamber capacity: 24 litre
- Loadless weight: 55 kg
- Power consumption: 2,300 W
- Supply Voltage: AC 230 V - 50/60 Hz
- Cycle water consumption*: 700 - 800 cc
- Tank capacity (clean and used water): 5 litres each
- Sound level: 60 dB (A)



CE
0051

** Water consumption varies depending on device operating conditions (e.g. chamber temperature, cycle selected, etc.).

Note: In all cycles the load indicated includes the trays.
Water must meet the requirements of the EN 13060 standard, Annex C.
Sterilisation parameters may vary depending on the type of load, weight and conditions of the autoclave. Refer to the User Manual (chapter 5.6).

SAFETY FEATURES	Blackout protection • Short-circuit protection • Overheating protection • Overpressure protection • Accidental door opening protection • Process evaluation system • Real-time troubleshooting system • Adaptive Heat system
CERTIFICATIONS	• Class IIb medical device compliant with Regulation (EU) 2017/745 on medical devices (MDR) (Article 16) • Chamber compliant with Directive 2014/68/EU • Company: ISO 9001 - ISO 13485
COMPLIANCE International standards	EN 13060 • IEC 61010-1 • IEC 61010-2-040 • IEC 61326-1 • EN 13445-1

Optional Accessories

Printer

Affordable and compact optional external printer, ideal for printing sterilisation data on paper or labels. Equipped with a USB cable and a power supply.



MODEL	ORDER CODE
Printer	9900009

Helix Test

Helix Test allows you to verify steam penetration into hollow instruments. Includes a tester and 250 indicators.



MODEL	ORDER CODE
Helix Test	9900059

Demin30

Complete demineralisation system of water

Demin30 is a demineralisation system with mixed-bed and ion-exchange resin, which enables the complete demineralisation of the water. Easy to install on various autoclave models, offering optimal performance and protection of sterilised instruments, extending the life of autoclaves or other reprocessing devices. The filter can be positioned on the worktop or inside the sterilisation cabinet. Demin30 can also supply demineralised water to a second autoclave.

Demin30 Kit

Direct connection water system

MODEL	ORDER CODE
Demin30 Kit	98001000

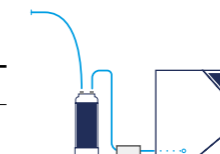

Demin30 Cartridge

Demineralisation resin filter

MODEL	ORDER CODE
Demin30 Cartridge	230000



Demin30 Kit

Top-loading water system

MODEL	ORDER CODE
Demin30 Kit	98001010

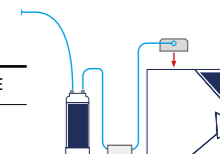

iClave plus EN 13060 : Class B & S

The iClave's copper chamber improves efficiency and capacity.

Air turbines, contra-angles, and other dynamic dental instruments consist of high-precision micro mechanisms and therefore benefit from careful sterilisation to maintain performance. NSK chose to use a highly conductive copper chamber to satisfy Class B, Europe's strictest sterilisation standard. The system delivers outstanding efficiency despite its large capacity.

Advantages

- More capacity
- Faster sterilisation
- More efficient drying phase
- More economical and environmentally friendly
- Gentle handpieces sterilisation



Improved Capacity

The iClave plus can fully use its 17.5 litre capacity because it maintains even temperatures throughout the autoclave chamber and constantly controls the surface temperature.



Copper chamber



Stainless steel chamber

High efficiency copper chamber improves total cycle times for faster throughput, saving time and money.

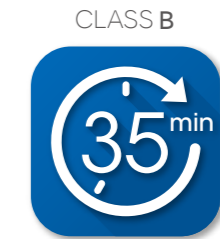

CLASS B

Super fast



CLASS S

Super fast

The copper chamber's superior thermal conductivity delivers outstanding performance

Copper Chamber

Using copper to construct the chamber gives 17.7 times more heat conductivity than stainless steel. The copper chamber retains even internal temperature levels throughout, enhancing the drying performance, helping protect instruments from corrosion, discolouration and damage.

Thermal Conductivity Differences of Materials

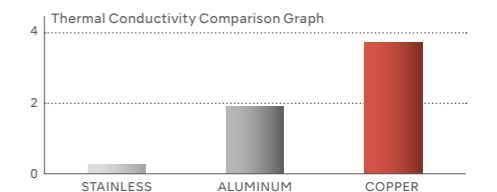

Copper's heat conductivity is 1.9 times and 17.7 times higher than that of aluminum and stainless steel, respectively.

Adaptive Heat System

Advanced heating system leveraging excellent thermal conductivity

NSK's innovative heating system optimises the high heat conductivity of copper. Enveloping the copper chamber is a special heater which is also used in satellites, incorporating electro-thermal material embedded in silicone to heat the entire chamber evenly without heat loss.



Advanced safety and durability through user-friendly functions.

Vacuum sterilisation for all types of instrument

A vacuum pump removes air from the chamber and handpiece cavities before sterilisation.

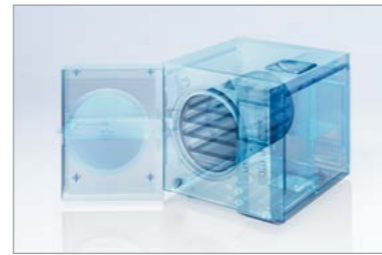

Bacterial ventilates for greater safety

The iClave plus ventilate air through a bacterial filter during the drying phase, eliminating the possibility of re-contamination.



Designed to boost product reliability

Consistent temperatures inside the chamber eliminate fluctuation stresses and reduce the risk of problems. NSK initially reviewed product reliability to ensure safe treatment. There are three temperature sensors to control temperatures in the iClave plus. An annual maintenance service alert helps prevent breakdowns and boosts product reliability.

Stainless steel body enhances durability

The stainless steel body work, which is rare for an autoclave these days, makes iClave plus more robust. Together with the copper chamber it delivers outstanding durability.

Constantly monitoring working parameters for safe operation

The process evaluation system constantly monitors pressure, temperature, water quality and steam. Additional features include cycle counter, altitude set-up, maintenance monitoring, triple safety lock, auto switch-off, and double water tank.

User-friendly, easy to read operating panel

With a sophisticated design and excellent visibility, the panel is easy to operate and maintain, with colours changing according to conditions, enhancing sterilisation reliability.

[Text colors] White: Selection screen Yellow: During operation
Green: Sterilization complete Red: Error

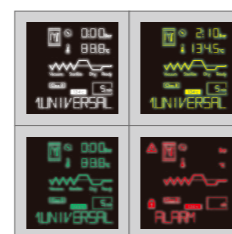

Sterilisation cycle data recording

All sterilisation cycles are recorded on a USB flash drive, and no special software is required to view and print records of all cycles. The system records all relevant cycle parameters against a unique date and time stamp.



iClave plus Complete Set

MODEL	ORDER CODE
iClave plus 230 V	Y1003077

Technical characteristics

- External dimensions : W 445 x D 585 x H 440 mm
- Chamber dimensions : ø240 x 384 mm
- Chamber capacity : 17.5 litre
- Net weight : 47 kg
- Maximum power consumption : 1,920 W
- Supply Voltage CE : AC 230 V - 50/60 Hz
- Air expulsion system : Vacuum pump 2, 3, 4 vacuum
- Max load : 4 kg (solid), 1.5 kg (porous)

External dimensions exclude protrusions.

	PROGRAMS	PARAMETERS			CLASS
1	UNIVERSAL	134°C	5 min	3 vacuum	B
2	DELICATE	121°C	20 min	3 vacuum	B
3	FLASH	134°C	3 min	2 vacuum	S
4	SMALL LOAD*1	134°C	4 min	3 vacuum	B
5	PRION	134°C	18 min	3 vacuum	B
6	CRITICAL 134°C	134°C	5 min	4 vacuum	B
7	CRITICAL 121°C	121°C	20 min	4 vacuum	B
8	SPECIAL	105-135°C	3-90 min	2-4 vacuum	-

• Bowie & Dick : 134°C / 3.5 min / 3 vacuum • Vacuum test : 20 min
*1 small load : included hollow instruments type A and B (MAX 0.5 kg)



Optional Accessories

Sealer Newseal

With high output, easily and automatically seals envelopes before sterilization.

- Self adjusting sealing from 10 mm
- Retracting blade cutter • Reel holder
- Visual and acoustic seal indication
- Pre-set for wall attachment

MODEL	ORDER CODE
Sealer Newseal	Z1279



Kit Wifi

Device for storing the sterilization cycles' data on an external memory and send to any PC, tablet or smartphone via WIFI connection.

MODEL	ORDER CODE
Kit Wifi	599011



Regenerating Tabs

A special effervescent tablet for cleaning the chamber. Placed inside the chamber, it removes limescale and dirt residue from the chamber upon activating the cycle.

MODEL	ORDER CODE
Regenerating Tabs	0230050



Helix Test

Helix Test allows you to verify steam penetration into hollow instruments. Includes a tester and 250 indicators.

MODEL	ORDER CODE
Helix Test	9900059



Barcode Label Writer

Increases traceability levels by combining sterile instruments and patients.

MODEL	ORDER CODE
Barcode Label Writer	Z1281



Purity

High quality water is essential for sterilisation. This customised RO unit fits on top of the iCare plus automatically filtering water from the mains supply.

MODEL	ORDER CODE
Purity	Z1284



PANA SPRAY Plus

PANA SPRAY Plus is a specially formulated, highly effective general handpiece and air motor lubricant. Frequent application of PANA SPRAY Plus will assure handpiece and air motor performance and durability. Apply PANA SPRAY Plus every time before autoclaving any handpiece or air motor.

MODEL	ORDER CODE	
PANA SPRAY Plus	Z182100	<ul style="list-style-type: none"> • For high & low speed handpieces, and air motors • 500 mL • Alcohol-based lubricant
PANA SPRAY Plus Package	Y900630	<ul style="list-style-type: none"> • PANA SPRAY Plus pack of 6

MODEL	ORDER CODE
Tip Nozzle ←	Z020201



PANA SPRAY Plus Nozzles 135°C

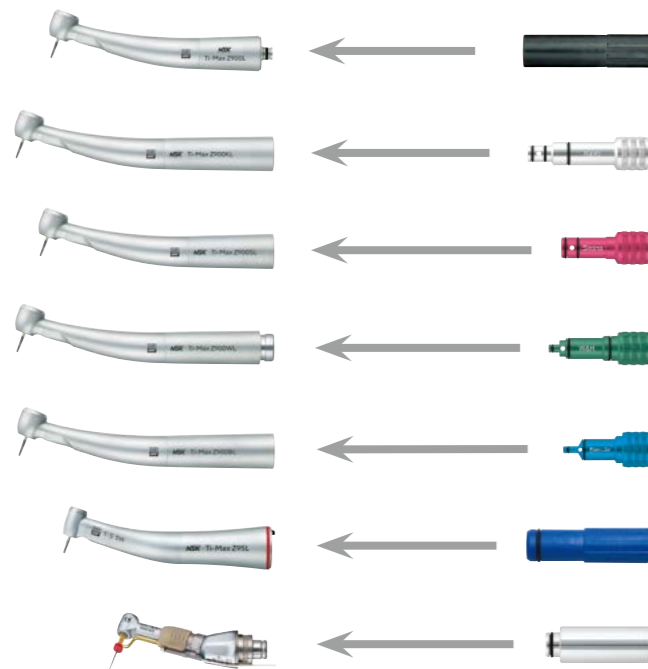

MODEL	ORDER CODE	
Phatelus Spray Nozzle	P183090	<ul style="list-style-type: none"> • For high speed attachments and air motors which attach to Phatelus and Mach couplings
KV Nozzle	Z090051	<ul style="list-style-type: none"> • For KaVo® Multiflex®
SR Nozzle	Z090052	<ul style="list-style-type: none"> • For Sirona® Quick coupling
WH Nozzle	Z090054	<ul style="list-style-type: none"> • For W&H® Roto Quick®
BA Nozzle	Z090053	<ul style="list-style-type: none"> • For Bien Air® UNIFIX®
E-Type Spray Nozzle	Z019090	<ul style="list-style-type: none"> • For E-Type* attachments
F-Type Spray Nozzle	Z256090	<ul style="list-style-type: none"> • For ENDO-MATE TC2 / DT2 & iSD900 heads

* E-Type : Conformable to ISO 3964.

Spray Mist Absorber

A convenient way to contain mist spray from escaping into the environment. Simply insert the handpiece into the absorber pack then apply the spray lubricant.

MODEL	ORDER CODE
Spray Mist Absorber	Y900084
• Pack of 10	



Multi Stands 135°C

NSK Multi Stand is the convenient way to organise and store NSK high and low speed handpieces and heads. Autoclavable at 135°C.



MODEL	ORDER CODE
Multi Stand Complete	Z036

• For NSK high speed and low speed attachments

MODEL	ORDER CODE
Multi Stand for Phatelus	Z036002

• 3 x adaptor A • 2 x adaptor C



Multi Stand Handpiece Adaptors 135°C

MODEL	ORDER CODE	
Adaptor A	Z036201	<ul style="list-style-type: none"> • For high speed handpieces and Phatelus air motors
Adaptor B	Z036202	<ul style="list-style-type: none"> • For E-Type* low speed handpieces and Phatelus air motor heads
Adaptor C	Z036203	<ul style="list-style-type: none"> • For Phatelus and Mach couplings
Adaptor KV	Z036204	<ul style="list-style-type: none"> • For KaVo® Multiflex®
Adaptor SR	Z036205	<ul style="list-style-type: none"> • For Sirona® Quick Coupling
Adaptor WH	Z036207	<ul style="list-style-type: none"> • For W&H® Roto Quick®
Adaptor BA	Z036206	<ul style="list-style-type: none"> • For Bien Air® UNIFIX®
Adaptor F	Z036209	<ul style="list-style-type: none"> • For ENDO-MATE TC2 / DT2 & iSD900 heads

* E-Type : Conformable to ISO 3964.

Spare Parts and Accessories

iCare+

MODEL	PRODUCTS	ORDER CODE
	Maintenance oil for iCare+ (1 litre) 	Z016117
	n.clean, 500 ml PEHD bottle (6 pcs) 	ACL600

MODEL	PRODUCTS	ORDER CODE
	n.cid, 500 ml PEHD bottle (6 pcs) 	ACD600
	E-type O-ring joint (Pack of 2) 	0312074080

MODEL	PRODUCTS	ORDER CODE
	Blister 	S103106

iCare

MODEL	PRODUCTS	ORDER CODE
	Maintenance oil for iCare (1 bottle, 1 litre) 	Z016130
	Chuck Cleaning Nozzle 	Z257301

MODEL	PRODUCTS	ORDER CODE
	Air Filter 	U508352
	HP Head Filter (Pack of 200) 	U1120118

MODEL	PRODUCTS	ORDER CODE
	Mist Filter Set (Pack of 12) 	Y900159
	Oil Absorber Sheet (Pack of 10) 	U433135

iClave 18 & 24

MODEL	PRODUCTS	ORDER CODE
	Printer 	9900009

MODEL	PRODUCTS	ORDER CODE
	Helix Test 	9900059

iClave plus

MODEL	PRODUCTS	ORDER CODE
	Sealer Newseal 	Z1279
	Helix Test 	9900059

MODEL	PRODUCTS	ORDER CODE
	Kit Wifi 	599011
	Barcode Label Writer 	Z1281

MODEL	PRODUCTS	ORDER CODE
	Regenerating Tabs 	0230050
	Purity 	Z1284

KaVo and Multiflex are registered trademarks of KaVo Dental GmbH.
Dentsply Sirona and Sirona are registered trademarks of Dentsply Sirona Inc.
W&H and Roto Quick are registered trademarks of W&H Deutschland GmbH.
Bien Air and UNIFIX are registered trademarks of Bien-Air Holding SA.

NAKANISHI INC. www.nsk-dental.com
700 Shimohinata, Kanuma
Tochigi 322-8666, Japan

NSK Europe GmbH www.nsk-europe.de
Elly-Beinhorn-Str. 8
65760 Eschborn, Germany

NSK United Kingdom Ltd. www.nsk-uk.com
Hertford House, Rutherford Close
Stevenage, Hertfordshire, SG1 2EF, UK

NSK Dental Nordic www.nsk-nordic.com
Furstenbergsgatan 4
41664 Gothenburg, Sweden

Specifications are subject to change without notice.